



Technical Data Sheet-DPH

DPH 5-PH5 Adjustable from 100 to 175 mm

COMPONENTS

DPH5-PH5 is composed of 3 pieces:

Slope corrector + DPH-5 PH5 pedestal + 4 lockings

keys.

CHARACTERISTICS

Top: \varnothing 155 mm, 188 cm²

Base: \varnothing 200 mm, 314 cm²

Weight: 0,667 kg

Height adjustable from 100 to 175 mm

Slope corrector is integrated in the head of the pedestal, providing slope correction from 0-5% (in 0,5 % intervals)

MATERIAL

Copolymer polypropylene (CPP)

Composition: +/- 80% first grade pre-selected recycled PPC, and +/- 20% Talc + Masterbatch black

Designed and manufactured in Europe

Use of recycled materials exclusively of EU origin

Resistant to weathering, sea salts, algae and a wide range of chemicals

Temperature range: -30 C° to +80 C°

PACKAGING

Pieces per carton: 24 pcs

Carton weight: 16,71 kg

Carton dimension: 600x 400 x 600 mm

Cartons per pallet: 25 pcs

Pieces per pallet: 600 pcs

Pallet dimensions: 100 x 120 x 220 cm

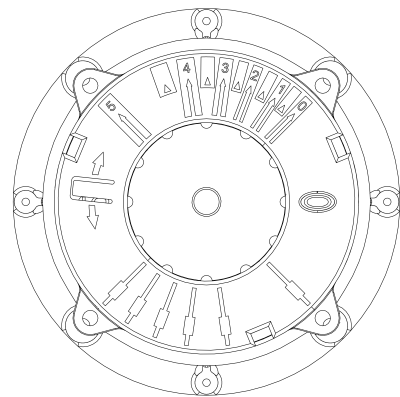
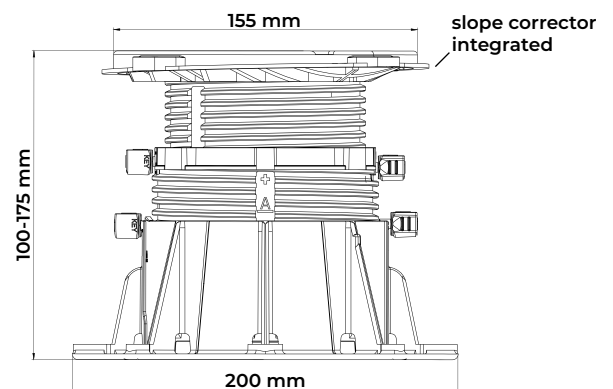

APPLICATIONS

Buzon pedestals can be used for a wide range of outdoor applications, such as terraces, pool decks and water features, in landscape areas and on rooftops... Finishing materials can be freely specified by the designer. Accessories are available for applications with various outdoor finishes, such as granite stone pavers, composite / timber decking, ceramic tiles and fibreglass or metal grating panels. Buzon pedestals can be installed on a wide range of solid and stable substrates, such as concrete slabs, cement screeds, waterproof membranes, insulation panels.

Spacer Tabs



Thickness: 3 and 4,5mm



Thickness: 2, 4,5, 6, 8 and 10mm

Batten Holder



Thickness: 4 mm
Joist max.: 65 mm

Shims



U-E10 (T = 1mm)
U-E20 (T = 2mm)

COMPRESSION TEST*

Performed on the full (1/1), half (1/2) and quarter (1/4) surface of the head (1kN= 100 kg= 224,8 lbF)

| Position | Height (mm) | Yield strength** (kN) | Yield strength (lbF) | Breaking load (kN) | Breaking load (lbF) |
|----------|-------------|-----------------------|----------------------|--------------------|---------------------|
| 1/1 | 175 | 10 (1 000 kg) | 2 248 | 16,4 (1 640 kg) | 3 686 |
| 1/2 | 175 | 5,5 (550 kg) | 1 236 | 11,5 (1 150 kg) | 2 585 |
| 1/4 | 175 | 3,5 (350 kg) | 786 | 6,9 (690 kg) | 1 551 |

* Tests carried out by SIRRIS.

** The yield point is the stress from which a material stops deforming in an elastic, reversible manner and thus begins to irreversibly deform (ISO472 :2013).

SAFETY INSTRUCTIONS

Buzon pedestals are designed to support external raised floors for pedestrian traffic only and are not designed to support or be subjected to moving and/or vibrating machinery & equipment, including maintenance, cleaning vehicles, automobiles and other similar equipment.



Buzon has a policy of continuous improvement and reserves the right to modify, revise or change the above specifications without notice. This brochure is for descriptive purpose only and is based on the product as on the date of publication of this information.

© Copyright Buzon Pedestal International SA Buzon DPH® is a registered trade mark of Buzon Pedestal International SA.

DPH-F17 17mm

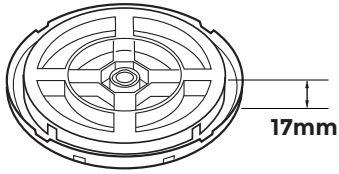

DPH-F28 28mm

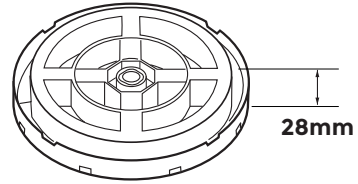

DPH-02 25-36mm

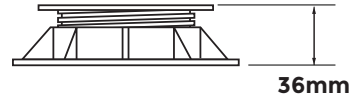
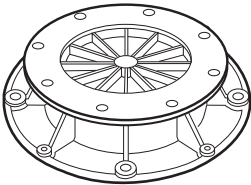

DPH-2 35-53mm

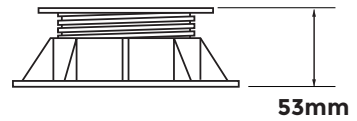
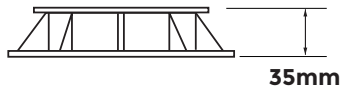
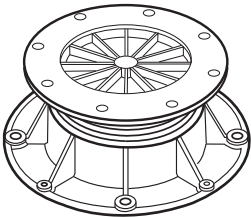

DPH-3 50-78mm

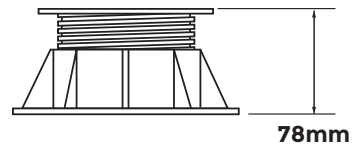
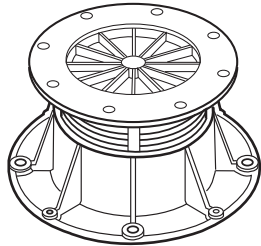

U-E20 2mm

Tabs

DPH-Series

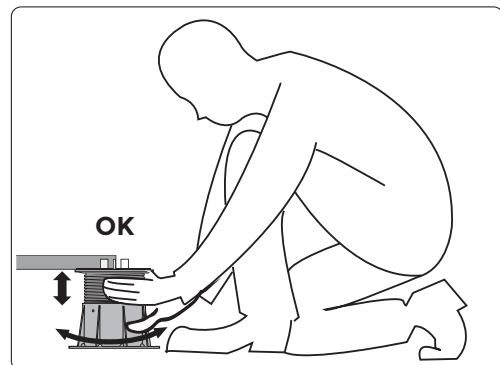
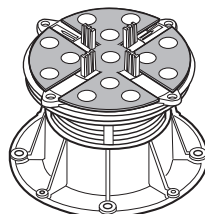
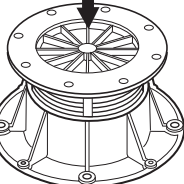
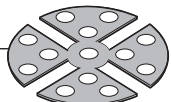

DPH-F17 + PH5 26mm

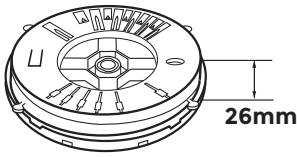

DPH-F28 + PH5 37mm

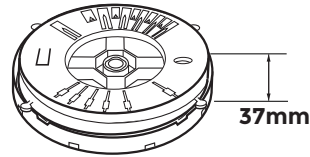

DPH-02-PH5 33-44mm

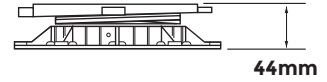
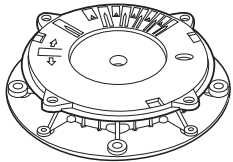

DPH-2-PH5 44-57mm

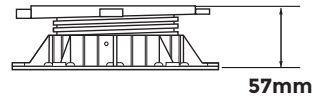
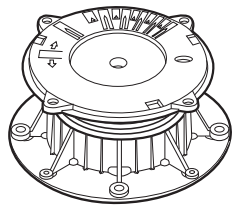

DPH-3-PH5 55-79mm

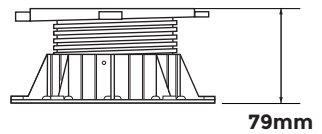
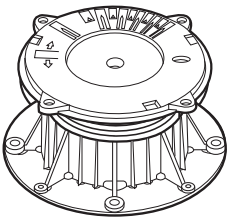

DPH-4-PH5 77-108mm

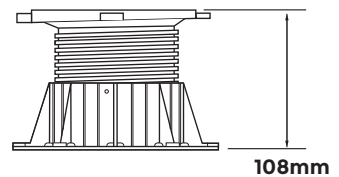
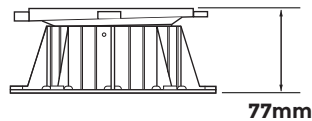
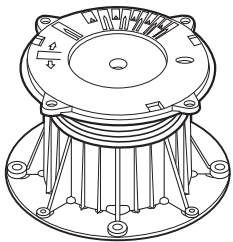

DPH-5-PH5 100-175mm

